



USER MANUAL

Energy Storage System

Please read this manual carefully before operating and retain it for future reference.

Model

LG Electronics ESS Home 5 (RBA005K0A0F)
Home 5 (RA500K16A11)
Smart Energy Box (REA200AP0)

LG Electronics ESS Home 8 (RBA008K0A00)
Home 8 (RA768K16A11)
Smart Energy Box (REA200AP0)



* M F L 7 1 8 7 9 3 0 1 *

Rev. H 17 / 04 / 2024

<http://www.lg.com/us/ess>

Copyright © 2022 - 2024 LGEUS All Rights Reserved.

Due to our policy of continuous product innovation, some specifications may change without notification.
©LG Electronics U.S.A., Inc., Englewood Cliffs, NJ. All rights reserved. "LG" is a registered trademark of LG Corp.

PROPRIETARY DATA NOTICE

This document, as well as all reports, illustrations, data, information, and other materials, are the property of LG Electronics U.S.A., Inc., and are disclosed by LG Electronics U.S.A., Inc. only in confidence.

Do not throw away, destroy, or lose this manual.

Please read carefully and store in a safe place for future reference.
Content familiarity is required for proper installation.

The instructions included in this manual must be followed to prevent product malfunction, property damage, injury, or death to the user or other people. Incorrect operation due to ignoring any instructions will cause harm or damage. The level of seriousness is described by the summary list of Important Safety Instruction.

For continual product development, LG Electronics U.S.A., Inc. reserves the right to change specifications without notice.
© LG Electronics U.S.A., Inc.

Important Safety Instructions

IMPORTANT: This product should not be used for any purpose other than the purpose described in the installation manual.

SAVE THESE INSTRUCTIONS : This manual contains important instructions for LG Electronics ESS Home 5/8 (RBA005K0A0F / RBA008K0A00) consisting of PCS (RA500K16A11 / RA768K00A10), Battery Module (BPLG004HBG1), and SE Box (REA200AP0) that shall be followed during the installation and maintenance of Energy Storage System (ESS).

The LG Electronics ESS Home 5/8 has been designed and tested to meet applicable North America and International safety standards. As with any electrical and electronic devices, safety precautions must be observed during the installation and operation of the LG Electronics ESS Home 5/8 to reduce the risk of personal injury and to ensure safe installation.

Installation, commissioning, service, and maintenance of the LG Electronics ESS Home 5/8 must be performed only by trained service providers who are licensed and/or who meet the applicable state, local jurisdiction regulations, follow the instructions in this manual, and using personal protective equipment (PPE). All transport or handling of the LG Electronics ESS Home 5/8 product must be done in accordance with local safety standards.

Before starting the installation or commissioning of the LG Electronics ESS Home 5/8, read through the entire manual and take note of all precautions.

All U.S. and Canada electrical installations must be done in accordance with local codes and the National Electric Code (NEC) ANSI/NFPA 70 or the Canadian Electrical Code CSA C22.1.

In Canada, the installation and wiring methods used must comply with parts I and II of the Canadian Electric Code, and local AHJ inspector requirements. When required by Part 1 of the Canadian Electrical Code, system grounding is the responsibility of the installer.

LG Electronics ESS system is not intended for use as a primary or backup power source for life-support systems, other medical equipment, or any other use where product failure could lead to injury to persons or loss of life or catastrophic property damage. LG disclaims any and all liability arising out of any such use of the system. Further, LG reserves the right to refuse to service any system used for these purposes and disclaims any and all liability arising out of LG's service or refusal to service systems in such circumstances.



DANGER

Indicates a hazardous situation that will result in death or serious injury if the instruction is not followed.

- Do not open the door. There are no user serviceable parts inside. Service may be performed only by trained service provider.
- Risk of electric shock from energy stored in capacitor. Do not remove the door until 10 minutes after disconnecting all sources when service needed.
- Electric shock hazard. Do not touch uninsulated wires when the product cover is removed.
- Do not disconnect, disassemble, or repair to avoid injuries, electric shock or burns.
- There is a high possibility of electric shock or serious burns due to the high voltages in the ESS.
- The AC cables are high voltage. Risk of death or serious injury due to electric shock.
- This product poses potential danger such as death or serious injury by fire, high voltages, or explosion if appropriate precautions are not read, fully understood, and followed.
- Do not place or install flammable or potentially explosive objects near the product or in explosive atmospheres.
- Do not charge or discharge arbitrarily. It may lead to fault, electric shock, or burns.
- Do not damage the unit in any manner, such as by dropping, deforming, impacting, cutting, or spearing with a sharp object. It may cause electrolyte leakage or fire.
- Breakdown of the unit may cause electrolyte leakage or flammable gas generation.
- If electrolytes leak, avoid contact with eyes, skin, or clothes. In event of accidental contact, flush with water and seek medical help immediately.
- Do not place near open flame or incinerate. It may lead to fire or explosion.
- Keep the unit away from moisture or liquid. Do not touch or use the product if liquids have been spilled on it.
- Keep out of reach of children or animals.
- Electrical installations must be done in accordance with local standards, national electrical safety standards, and the manufacturer's instructions.
- The battery system is a bidirectional source of voltage. The battery circuit breaker and inverter must both be off before working in the wiring box.
- Disconnect each circuit individually before servicing. Both AC and DC voltage sources are terminated inside this equipment.
- Do not dispose of batteries in a fire. The batteries may explode.
- Do not open or assemble while product is working.



**Indicates a potentially dangerous situation.
Death or serious injury may result if appropriate
precautions are not taken.**

- A potentially hazardous circumstance such as excessive heat or electrolyte mist may occur due to improper operating conditions, damage, misuse and/or abuse.
- The contents included in this box are the ESS and its accessories. The total weight is very heavy. Serious injury may occur due to the weight of the package containing the ESS and accessories. Therefore, special care must be taken in handling. Make sure to use the handle lift to deliver and install the package.
- Do not open or damage batteries. Released electrolyte is harmful to the skin and eyes. It may be toxic.
- Do not place heavy objects on this product. It may cause deformation or fracture.
- Do not place any kind of objects on top of the product during operation.
- All work on the ESS must be carried out by trained service providers only.
- Electrical installations must be done in accordance with the local and national electrical safety standards.
- Wear rubber gloves and protective clothing (including protective glasses and boots) when working on the ESS.
- To reduce the risk of fire, do not connect to an AC load center (circuit breaker panel) with multiwire branch circuits connected.







CAUTION

Indicates a situation where damage or injury may occur. If it is not avoided, minor injury and/or damage to property may result.

- Before testing electrical parts inside the system, there is a minimum of a 10 minute standby period to completely discharge the system.
- Do not use any damaged, cracked, or frayed electrical cables or connectors. Protect the electrical cables from physical or mechanical abuse, such as being twisted, kinked, pinched, closed in a door, or stepped on. Periodically examine the electrical cables of your product. If the appearance indicates damage or deterioration, discontinue use of this product and have the cables replaced with an exact replacement part by a qualified personnel.
- Ensure that you connect the earth ground wire to prevent possible electric shock. Do not try to ground the product by connecting it to telephone wires, lightning rods, or gas pipes.
- Do not put the product or components in water or liquid.
- Make sure that there are no water sources, such as faucets or sprinklers, near the installation site.
- Do not block any ventilation openings. Ensure reliable operation of the product and protect it from overheating. Do not block any openings by placing objects on this product.
- The metal enclosure may heat to a high temperature during operation.
- The product must be disposed of according to local regulations.
- If the ESS has been stored for a lengthy period prior to installation, the battery may be over-discharged.
- Do not step on the product or the product package. The product may be damaged.
- Batteries may present a risk of electrical shock and high short-circuit current. The following precautions should be observed when working on the ESS system include:
 - a) Remove watches, rings, and other metal objects.
 - b) Use tools with insulated handles.
 - c) Wear rubber gloves, boots, and glasses.
 - d) Do not lay tools or metal parts on top of the system.
- In the event of fault, the system must not be restarted. Product maintenance and repairs must be performed by trained service providers.
- If a system fault occurs immediately after starting the system, check the error code on the Smart Energy Box (SE Box) display and follow the solution described in the manual.

INFO Indicates a risk of possible damage to the product.

- The System consists of Home 5/8 and SE Box. They must be installed together and it will not work when installing unauthorized components to the system.
- The unit is designed to feed power to the public grid only. Do not connect the unit to a generator as connecting the power to external devices could result in serious damage to the equipment.
- LG Electronics ESS Home 5/8 performs best when it is connected to the internet and registered through the ThinQ service, so that the firmware may be remotely updated periodically.
- To download the latest ESS documents, Please scan the QR code below with your smartphone.

Warranty	Installation	User Manual	Quick Installation Guide
			

- If the S/W version is not up to date during installation, update the S/W using a FAT32 formatted USB storage device. When the SE Box is connected to Ethernet through a LAN cable after normal operation, it is automatically updated to the latest S/W version.
- Handling of batteries should be performed or supervised by a trained service provider.
- The battery does not discharge when the load is under a certain level.
- To prevent network problems, check the "Network Settings" before installation.
- Do not store or place any objects on top of or against the unit. It may cause serious malfunction or other problems.
- Never use any solvents, abrasives, or corrosive materials to clean this unit.
- Under backup operation, whether the battery SoC is higher than 90% or the ESS needs to reduce the charging power, the ESS may reduce the solar power generation.
- If the battery SoC is too low during backup operation during a power outage, the system operates as follows.
 - Even though the PV system is equipped, the system will not supply power to the home load. However, the system can charge the battery from the PV system first and then supply power to the home again if the battery SoC is sufficiently charged.
 - If the PV system is not equipped, the system cannot supply power to the home load and the system will go into sleep mode.

First Aid Measures

The Product includes internal fault mechanisms designed to prevent failures and subsequent risk hazards. However, LG Electronics cannot guarantee the safe performance of the Product if it is ever exposed to abuse, damage, or negligence.

If a user happens to be exposed to the internal materials of the battery cell due to damage on the outer casing, the following actions are recommended.

- In case of inhalation: Leave the contaminated area immediately and seek medical attention.
- In case of contact with eyes: Rinse eyes with running water for 15 minutes and seek medical attention.
- In case of contact with skin: Wash the contacted area with soap thoroughly and seek medical attention.
- In case of ingestion: Induce vomiting and seek medical attention.

Fire Fighting Measures

Suitable extinguishing media

Use a foam extinguisher containing CO₂, powder graphite, Class ABC or D dry chemical, sodium carbonate, or dry sand if only a few cells are involved. In case of fire propagation use a large amount of water to extinguish.

Special hazards arising from the chemical

May form hydrofluoric acid if electrolyte comes into contact with water.

In case of fire, the formation of the following flue gases cannot be excluded: Hydrogen fluoride (HF), Carbon monoxide, and carbon dioxide.

Protective equipment and precautions for firefighters

If batteries are charging, shut off power.

Wear a self-contained breathing apparatus and protective suit.



WARNING

If heated above 130 °C (266 °F), there is a risk of fire, explosion, physical injury, or death.

Effective way to deal with accidents

- On land : Do not touch the damaged battery and call your local fire department or service engineer.
- In water : Stay out of the water and do not touch anything if any part of the ESS or wiring is submerged.
- Do not use the submerged battery again. Contact your service engineer for assistance.

Table of Contents

Getting Started

Important Safety Instructions	3
First Aid Measures	8
Product Features	10
Part Names	15
Front and Rear (Home 5/8)	15
LED Indications (Home 5/8)	16
Front and Rear (SE Box)	17

Settings

Opening the SE box door	18
About the HOME Screen	19
User Settings	21
General Settings	21
PCS Settings	28
Using LG ThinQ® Applications (For User)	32
Installing LG ThinQ®	32
Using LG ThinQ®	33

Troubleshooting

Error Codes and Messages	35
PCS Error Codes	35
SE Box Error Code	37
Battery Error Code	38

Appendix

Black Start	42
Maintenance	43
Cleaning the Product	43
Inspecting Regularly	43
Shutting Down the System	43
Compliance Information	44
Specifications	46

Product Features

This product is an All In One Energy Storage System (ESS) designed with a grid-connected inverter and integrated battery. Also, it is possible to supply power in case of a power outage through the Smart Energy Box (SE Box). The built-in PMS (Power Management System) in SE Box provides the optimal charging/ discharging operation by monitoring the home power usage status, PV power generation, grid power status, consumer electricity plan, and weather forecast. ATS function can be enabled for backup power in the built-in PMS, which can provide automatic seamless transfer switching.

(In order to use all functions smoothly, users must connect this product to the Internet and subscribe to the LG ThinQ® service.)

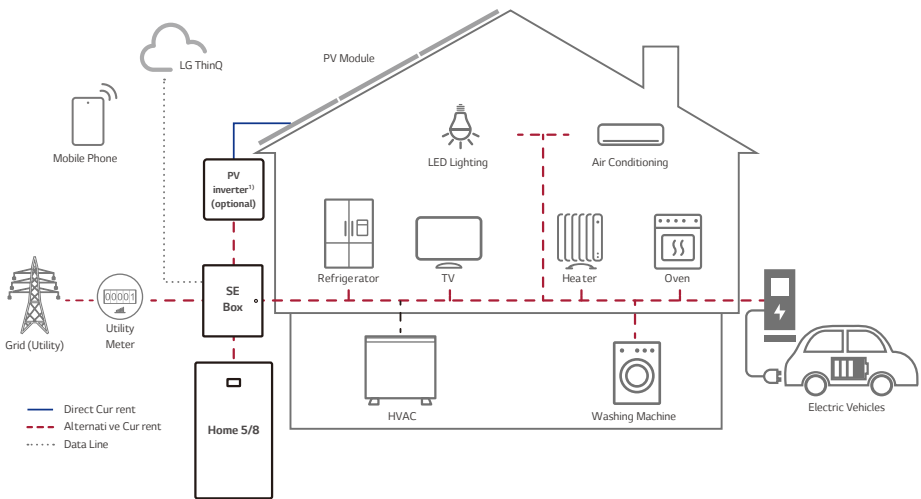

1) PV inverter is NOT PROVIDED by LG Electronics.

- **All In One ESS**

LG Electronics ESS Home 5/8 is a product designed to integrate a grid-connected inverter and battery in one enclosure. This product is an AC-Coupled type and is directly connected to the household power grid.

- **Single-phase Three-wire Connection (Split Phase Only)**

This product is for use exclusively for single-phase three-wire electric power grids used in the home.

- **Smart Management**

The built-in Smart PMS analyses PV generation, load consumption, electricity rate, and weather information. It also monitors the main system & battery conditions to maintain a stable condition. Internet connection and LG ThinQ® connection required.

- **App & Web-Monitoring Service**

The home owner and installer can monitor their ESS with various devices such as a PC, tablet, or smart phone.

- **Backup Mode**

During a power outage, this system supplies emergency power to the household loads. When the grid experienced an outage, SE Box can automatically switch the power source from the utility grid to Home 5/8. For these functions, “Backup” should be enabled in the system.

- **System Scalability**

Up to 4 Home 5/8 units can be connected to one SE Box. (The required number of Home 5/8 may vary depending on the electric service capacity, the load consumption characteristic, and the preferred operation of the home. Please contact an authorized dealer or the seller for more details.)

Home 5 and 8 are mixed with each other and cannot be connected.

System configuration

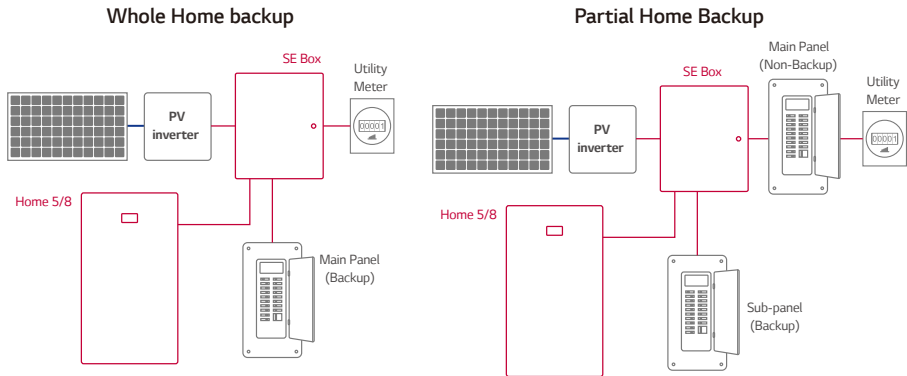

Product Specifications















All specifications and descriptions contained in this document are verified to be accurate at the time of printing. However, since continuous improvement is a goal at LGEUS, we reserve the right to make product modifications at any time.







The images provided in this document are for demonstration purposes only. Depending on product version and market region, details may appear slightly different.

©2022 - 2024 LGEUS Inc. All rights reserved.

Due to our policy of continuous product innovation, some specifications may change without notification. ©LG Electronics U.S.A., Inc., Englewood Cliffs, NJ. All rights reserved. “LG” is a registered trademark of LG Corp.

Symbol Used on Labels

Symbol	Description
	UL approval Listing Mark
	UL approval Recognized
	Risk of Electric Shock
	Identifies any terminal intended for connection to an external conductor for protection against electrical shock in case of a fault or the terminal of a protective earth (ground) electrode.
	Read the instruction manual/booklet before starting work or before operating equipment or machinery.
	Caution, risk of danger
	Caution, hot surface
	Caution, risk of electric shock, energy storage timed discharge
	Caution, risk of electric shock
	No open flame, open ignition source, or smoking
	Wear protective glasses when working on the battery unit.
	Install this product out of reach of children.
	Take care when handling corrosive substances.
	Take care when handling explosive materials.
	Serious injury may occur due to the heavy weight of the product.

Symbol	Description
	Observe precautions for handling electrostatic discharge sensitive devices.
	Disconnect the machine or equipment before carrying out maintenance or repair.
	Take care to avoid causing a fire by igniting flammable material.
	Ensure adequate ventilation of the charging area and take care to avoid coming in contact with acid.
	In case of contact with acid material, immediately flush the area with plenty of water. Get medical attention immediately. Wash contaminated clothing before reuse with sufficient water.
	Fire extinguishers must be used to put out flames.
	Ensure the conductive terminals are matched to their corresponding counterparts.

Abbreviations in this Manual

Abbreviation	Designation	Explanation
ESS	Energy Storage System	Inverter system that stores energy in a battery and uses it.
Home 5/8	All In One unit	Battery integrated PCS
SE Box	Smart Energy Box	Micro-grid interface device that consist of an ATS (automatic transfer switch), energy meter, and Smart Controller.
PCS	Power Conditioning System	A device intended to convert AC/DC electricity to charge and discharge the battery.
PMS	Power Management System	A device to control the whole system, including the power management algorithm, and to communicate with the cloud server.
ATS	Automatic Transfer Switch	A device to separate the home micro grid from the utility grid.
PV	Photovoltaic	A solar panel system that converts solar energy into direct current electricity.
SoC	State of Charge	The current charge level of a rechargeable battery relative to its capacity.

Abbreviation	Designation	Explanation
BCU	Battery Control Unit	An electronic system that control a rechargeable battery system for securing battery safety.
DC	Direct Current	-
AC	Alternating Current	-
DHCP	Dynamic Host Configuration Protocol	Standardized network protocol used on Internet Protocol (IP) networks for automatic distributing network configuration parameters, such as IP addresses for interfaces and services.
LAN	Local Area Network	A network that interconnects computers within a limited area.
IP	Internet Protocol	A set of rules for sending data across a network.

Part Names

Front and Rear (Home 5/8)

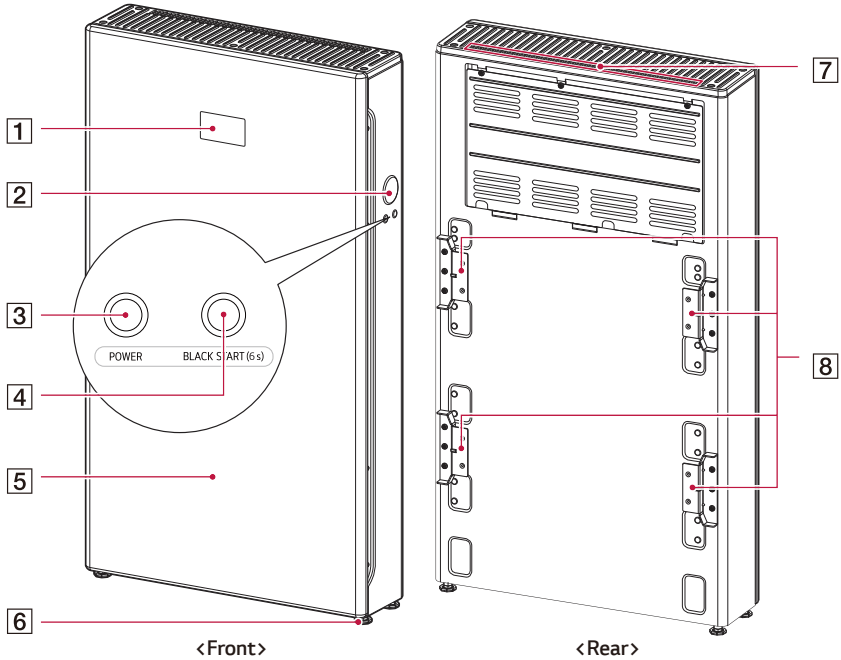



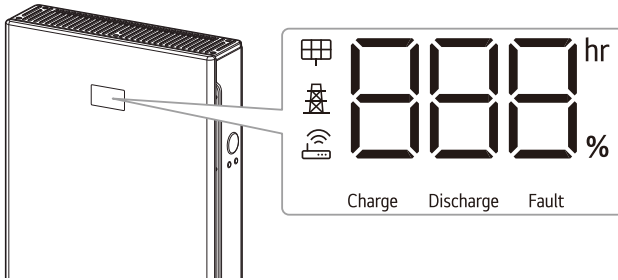

- 1** LED Indications
- 2** Conduit knockout
- 3** POWER button (Push type, ON/OFF toggle button)
- 4** BLACK START (6s) button
(Momentary type, press and hold for 6 seconds)

- 5** Front cover
- 6** Height leveling adjustable leg
- 7** Ventilation opening
- 8** Bracket connected parts

LED Indications (Home 5/8)



LED	Status and Indications		
 (PV)	Green	Red	Red Blink + Error code
	Generating	Not generating	SE Box Fault
 (Grid)	Green	Red	Red Blink + Error code
	Normal	Abnormal	PCS Fault
 (Gateway)	Green	Red	Red Blink + Error code
	Connected	Not Connected	Battery Fault
	SoC level + %	Remaining time + hr	Error code
	On-Grid	Backup operation	Fault
Charge	On	Off	
	BAT. Charging	Not operating	
Discharge	On	Off	
	BAT. Discharging	Not operating	
Fault	On	Off	
	Fault	Normal	

Front and Rear (SE Box)

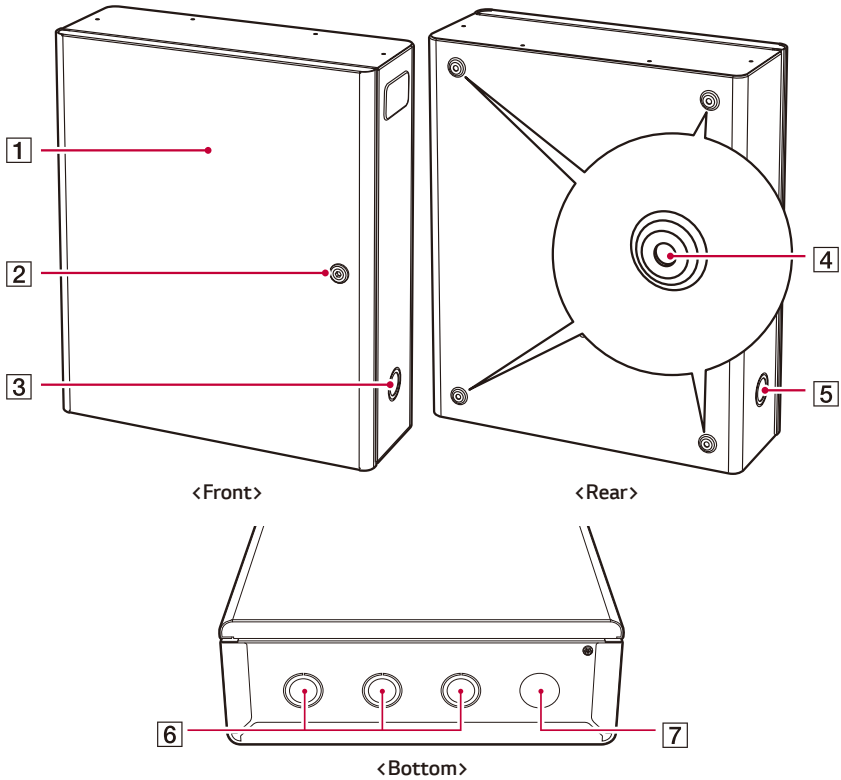

- 1** Front cover
- 2** Cover lock
- 3** Conduit knockout (right)

- 4** Wall support screw holes (4 points)
- 5** Conduit knockout (left)
- 6** Conduit knockouts (bottom)
- 7** Conduit hole (bottom)

Opening the SE box door

To operate the touch-screen display of SE Box, you should open the front door. Use a flat head screwdriver to open the door as shown in the figure.

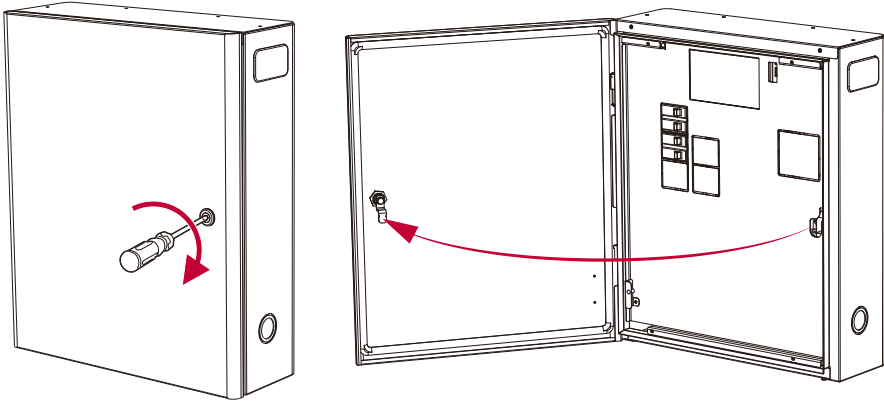

INFO

- Touch operation may not be possible when wearing gloves.
- Touch operation may not work if your fingers are wet or sweaty.

About the HOME Screen

The HOME screen displays and indicates the current system status. You can also check several settings and other information on the HOME screen.

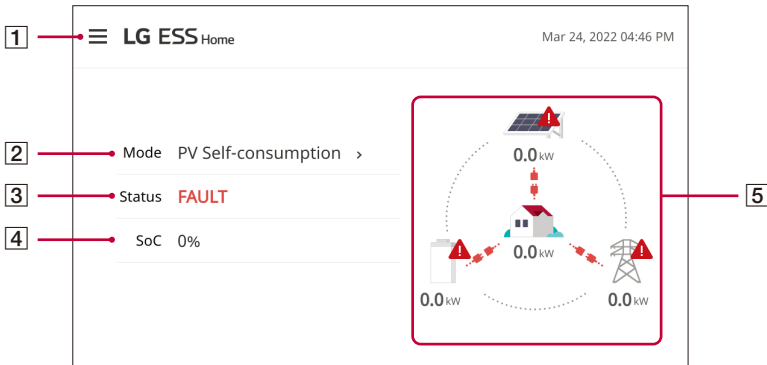

- 1 Displays the sub-menu.
- 2 Displays the currently running mode.
- 3 Displays the system status. (WAITING, CHARGING, DISCHARGING, WARNING, FAULT, STANDBY, STOP, DISCONNECTED, BACKUP, EXTERNAL SHUTDOWN, EMERGENCY CHARGING)
- 4 Displays the charge status of the battery.
- 5 You can check the power flow and error messages for the PV, Battery, Grid, and Home load.

If there are 2 or more Home 5/8 units installed in the system, each Home 5/8's status and error messages are displayed on the HOME screen as shown below.

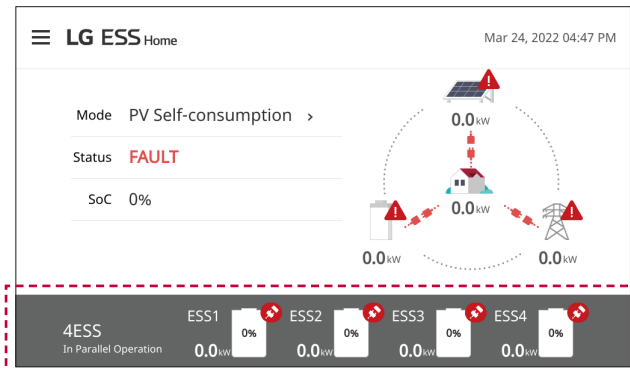

Errors

If an error occurs in the SE Box or Home 5/8, the current error information is displayed in the Event History. Press  to show the errors.

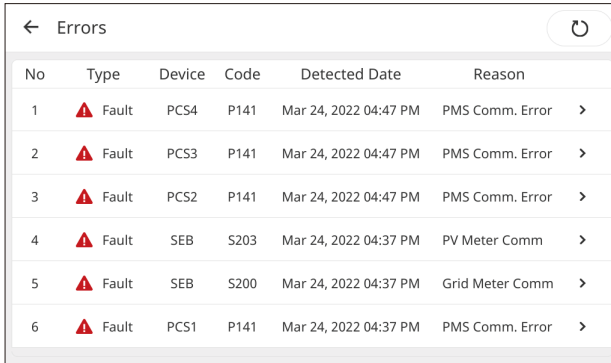

No	Type	Device	Code	Detected Date	Reason
1	Fault	PCS4	P141	Mar 24, 2022 04:47 PM	PMS Comm. Error
2	Fault	PCS3	P141	Mar 24, 2022 04:47 PM	PMS Comm. Error
3	Fault	PCS2	P141	Mar 24, 2022 04:47 PM	PMS Comm. Error
4	Fault	SEB	S203	Mar 24, 2022 04:37 PM	PV Meter Comm
5	Fault	SEB	S200	Mar 24, 2022 04:37 PM	Grid Meter Comm
6	Fault	PCS1	P141	Mar 24, 2022 04:37 PM	PMS Comm. Error

[Type] shows the severity of the error, [Device] shows the information of the device where the error occurred, and [Code] shows the error code.

Backup History

If the system is in backup mode due to a power outage, you can check the time when the backup started, the time the power outage ended, and how long the power outage was maintained.

Press  > [Backup History] to show the event history.

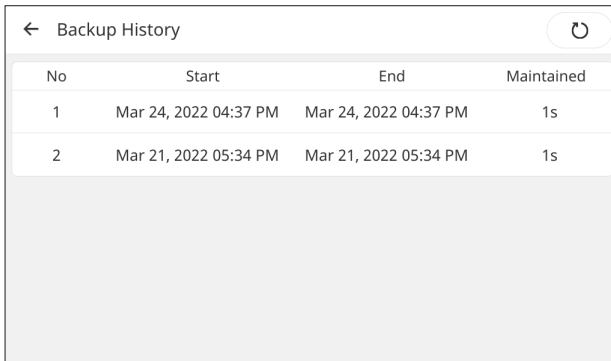

No	Start	End	Maintained
1	Mar 24, 2022 04:37 PM	Mar 24, 2022 04:37 PM	1s
2	Mar 21, 2022 05:34 PM	Mar 21, 2022 05:34 PM	1s

User Settings

The installer or user may need to change the system settings, even if all of the settings were set when the system was initially installed.

Press  > [Settings] to enter the [User] settings menu.

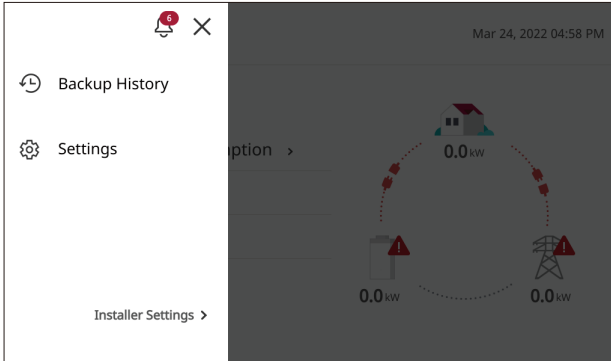

General Settings

Country

Press the currently selected country and select the desired country to change.

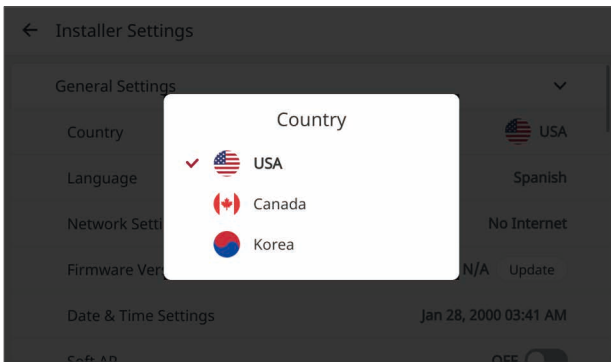

Language

Press the currently selected language and select the desired language to change.

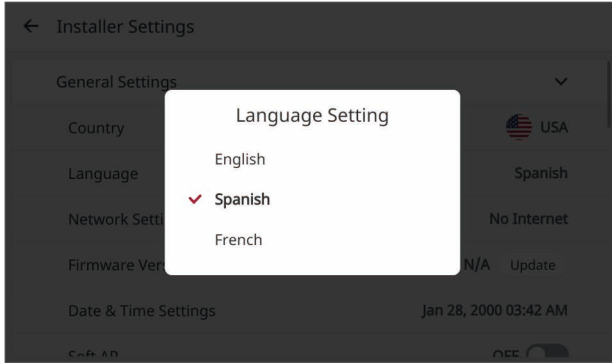

Network Settings

You can choose the network setting for the system. Select the connection type, either [Wired] or [Wireless].

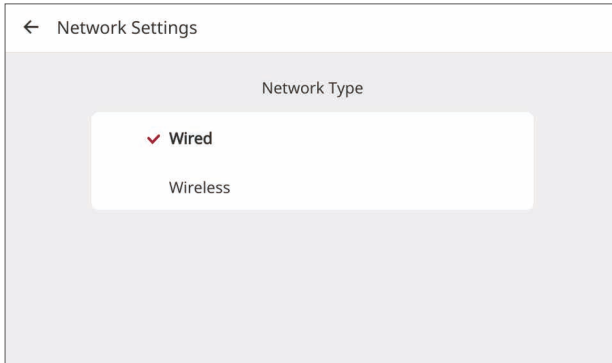

Wired

If the network is connected by an ethernet cable, select [Wired] on the [Network Settings] screen.

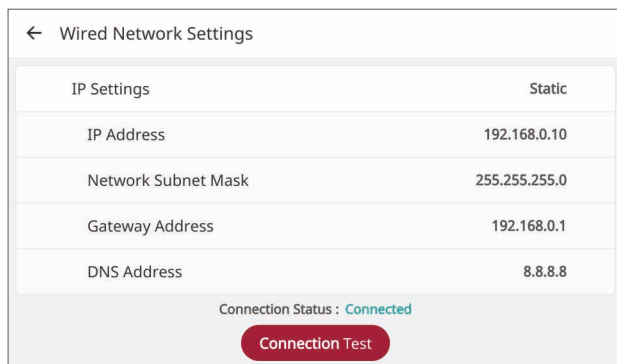

If the [IP Settings] option is set to [DHCP], the system will automatically be allocated an IP address from the local area network (LAN) through the wired connection. You may need to set the network connection manually depending on the network conditions. In this case, press [DHCP] to change to [Static].

If you set the [IP Settings] option to [Static], fill in the [IP address], [Network Subnet Mask], [Gateway Address] and [DNS Address] options manually and press [Apply] to apply the network settings.

Wireless

If you want to use a wireless network connection, select [Wireless] on the [Network Settings] screen. Available SSIDs are listed on the screen.

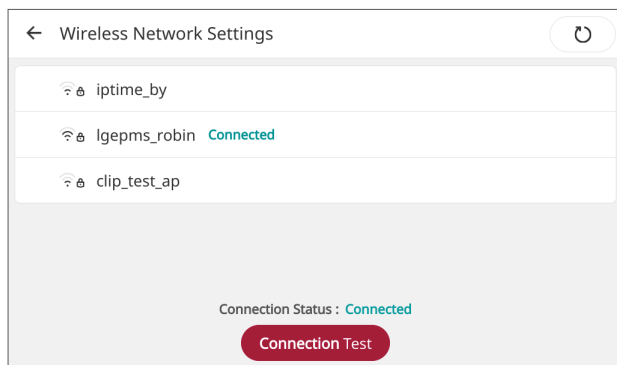

Select a SSID you would like to connect the system on the SSID list.

Input password of the SSID in the [Password] field.

After entering all the fields, tab [Connect] to finish the wireless network connection.

LG SE Box provides both wired and wireless internet connection. Depending on the SE Box location and the router, the wireless signal may be too weak to connect to the internet. The HMI screen on the SE Box will display a warning sign as shown below if the wireless signal is too weak.

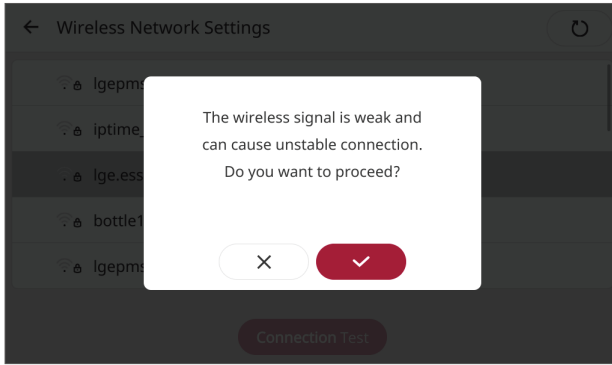

It is also necessary to check if the signal strength is sufficient under poor conditions (such as while the entrance or garage door is closed) during usage. If the signal is not strong enough to connect the internet, please consider installing the LG SE Box as close as possible to the router or install a WiFi range extender or Signal Booster.

INFO

- Many network connection problems during set up can often be fixed by re-setting the router or modem. After connecting the product to the home network, quickly power off and/or disconnect the power cable of the home network router or cable modem. Then power on and/or connect the power cable again.
- Depending on the internet service provider (ISP), the number of devices that can receive internet service may be limited by the applicable terms of service. For details, contact your ISP.
- LGEUS is not responsible for any malfunction of this product and/or the internet connection feature due to communication errors/malfunctions associated with your broadband internet connection, or other connected equipment.
- Some internet connection operations may not be possible due to certain restrictions set by the Internet service provider (ISP) supplying your broadband Internet connection.
- A 10 Base-T or 100 Base-TX LAN port is required for wired connection to this product. If your internet service does not allow for such a connection, you will not be able to connect this product.
- A DSL modem is required to use DSL services and a cable modem is required to use cable modem services. Depending on the access method and subscriber agreement with your ISP you may not be able to use the internet connection feature contained in this product or you may be limited to the number of devices you can connect at the same time. (If your ISP limits connections to one device, this product may not be allowed to connect when a PC has already been connected.)

INFO

- The use of a “Router” may not be allowed or its usage may be limited depending on the policies and restrictions of your ISP. For details, contact your ISP directly.
- Turn off all unused network equipment in your local home network. Some devices may generate network traffic.
- For the purpose of better wireless transmission, install the SE Box as close as possible to the access point.
- In some environments, placing the access point at least 0.45 m above the ground may improve the reception.
- When using a wireless network connection, remove all obstacles between the SE Box and the access point for better transmission.
- The reception quality over wireless depends on many factors such as type of the access point, distance between the SE Box and access point, and the location of the SE Box.

Firmware Version

You can check the current firmware version and update the firmware.

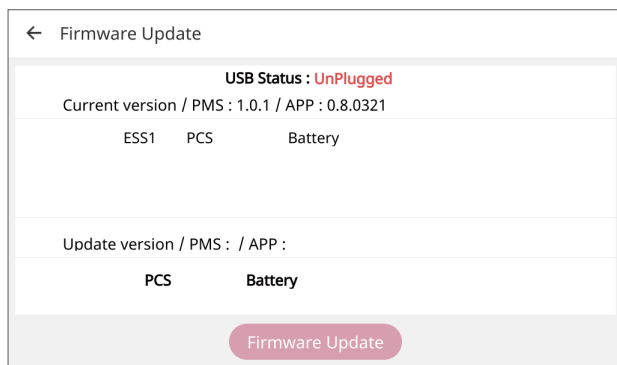

How to update the firmware.

Before updating the firmware, you need to store the latest firmware on a USB storage device and insert the USB storage device to the USB connector on the SE Box.

When the [USB Status] field displays [Plugged] on the screen, the firmware is ready to update.

Press [Firmware Update] to start the firmware update.

Date & Time Settings

You can set the current date and time.

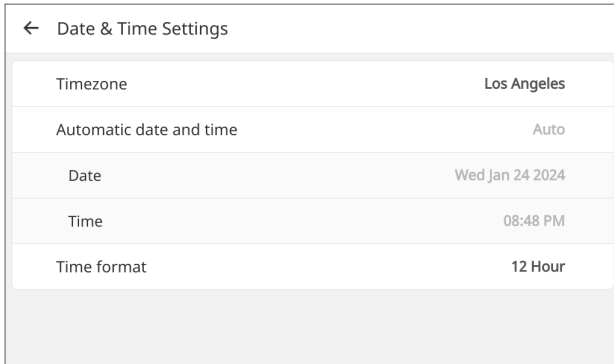

Timezone

Press [Timezone] and select the time zone for the region where the system is located.

Automatic date and time

If you set this option to [Auto], the date and time settings are automatically set through the internet.

Date / Time

You can set the date and time manually. Press [Date] or [Time] and set the current date and time.

Time format

Press [Time format] and select either [12 Hours] or [24 Hours].

Soft AP

The Soft AP (Software enabled Access Point) function provides a virtual AP function so that you can connect to the system through the LG ThinQ® App on a mobile device.

Press the ON/OFF switch to enable or disable this function.

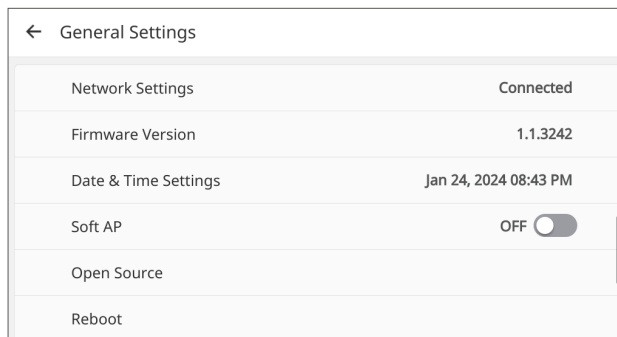

INFO

To use the Soft AP function, you need to register your system through the LG ThinQ® App. Refer to the LG ThinQ® App guide for detailed information.

Open Source

Press [Open Source] to see the Open Source Software Notice.

The screenshot shows the 'Open Source Software Notice' page with the following table:

Open Source	License	Copyright
ac1.2.4.52	GPL-2.1	Copyright (c) 1999-2002 Andreas Gruenbacher, <a gruenbacher@bestbits.at> Copyright (c) 2009-2002 Silicon Graphics, Inc.
ath.2.4.4f	GPL-2.1	Copyright (c) 2002 Andreas Gruenbacher <agruen@truse.de>, SuSE Linux AG. Copyright (c) 2001-2003,2005 Silicon Graphics, Inc.
audit.2.3.2	GPL-2.0 GPL-2.1	Copyright (c) 1994-2013 Free Software Foundation, Inc. Copyright (c) 2013 Red Hat Inc., Durham, North Carolina.
base-passwd.3.5.29	GPL-2.0	Copyright (c) 1989-2002 Wilbert Akkerman <wilbert@deephackmode.org> Copyright (c) 2002, 2003, 2004 Colin Watson <cwatson@debian.org>
bash-completion.2.7	GPL-2.0	Copyright (c) David Paleino (Debian) Copyright (c) Freddy Vuille Copyright (c) Guillaume Rousse (Mandriva) Copyright (c) Igor Muzrov Copyright (c) Mike Kelly (Ubuntu) Copyright (c) Santiago M. Mola (EulerOS) Copyright (c) Ville Skyttä (Fedora/Red Hat)
BurxBot.1.27.2	GPL-2.0	Copyright (c) 1999-2005, Erik Andersen <andersen@codepoet.org>
ca-certificates.20170717	GPL-2.0 FDL-1.0	Copyright (c) 2003, Fumihiko Ueki <ukei@debian.org> Copyright (c) 2008, Philipp Kern <pkern@debian.org> Copyright (c) 2011, Michael Stuber <mstuber@debian.org>

Reboot

Press [Reboot] to turn off and restart the system.

Reset Settings

Press [Reset Settings] to initialize user settings and restart the system.

PCS Settings

Operation

Press the [Start/Stop] switch to enable or disable the system operation.

System Information

You can check the system information on the screen. If the loaded information is not correct, press [Rescan] to retrieve the information.

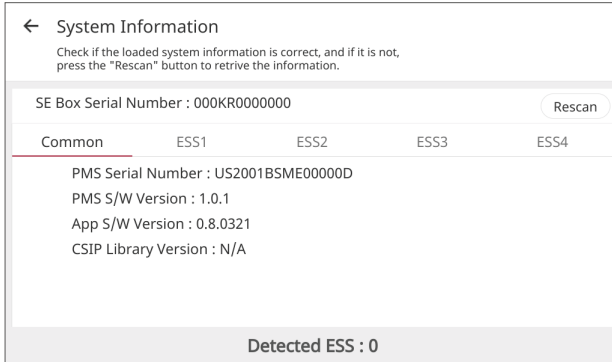

System Name

Press [PCS Settings] > [System Name] to set a system name.

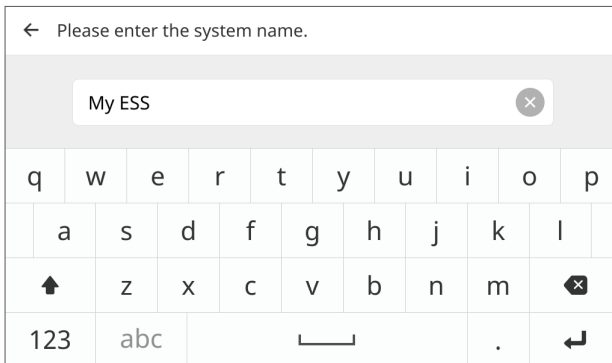

Operating Mode

You can select a operating mode.

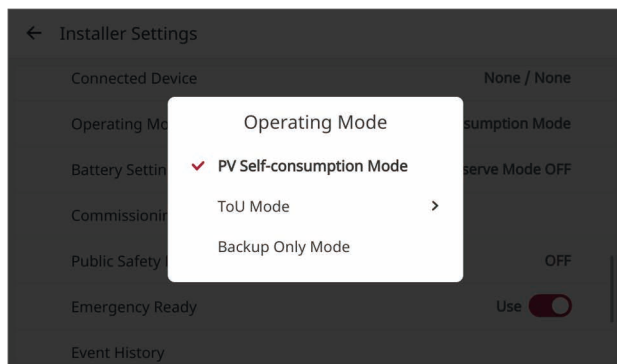

PV Self-consumption Mode

This mode operates by minimizing the power used in the system. Power generated from solar power is supplied to the load and the battery is charged with the remaining surplus power. When the battery is fully charged, the surplus power is supplied to the grid. If the load used power is greater than the solar power, the power stored in the battery is used.

ToU Mode

In this mode, charging/discharging is performed for each section by directly inputting the rate applied for each time period.

Available tables are [Season1/Weekday], [Season1/Weekend], [Season2/Weekday], [Season2/Weekend], [Season3/Weekday] and [Season3/Weekend].

Backup Only Mode

This mode fully charges the battery in case of a power outage. If this mode is selected, the battery is fully charged and it is not discharged until the mode is changed.

Battery Settings

You can set battery's reserve SoC level in case of a power outage. The default level is set to 20%.

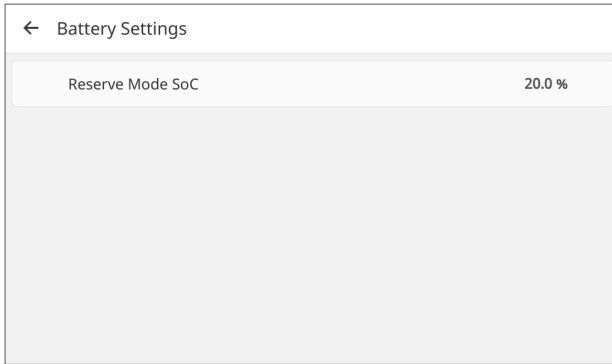

Public Safety Power Shutoffs

If utility companies expect a wildfire or natural disaster, they notify the user of it. After receiving the information, the user can set this function. When you set the start and end time/date, the system fully charges the battery before the set time, considering the current time, the current SoC, and the function start time.

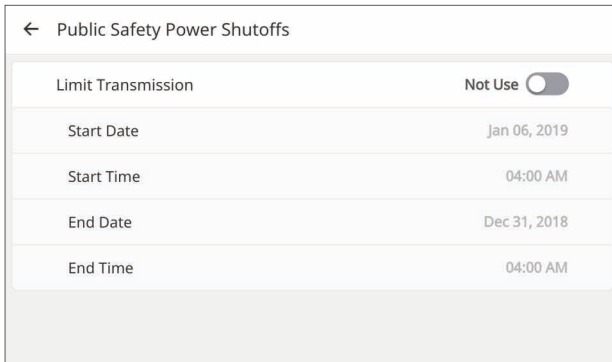

Emergency Ready

This function is a method of operating the system to prepare for an insufficient electricity supply due to bad weather that may occur in the near future. Press the [Use/Not Use] switch to enable or disable the function.

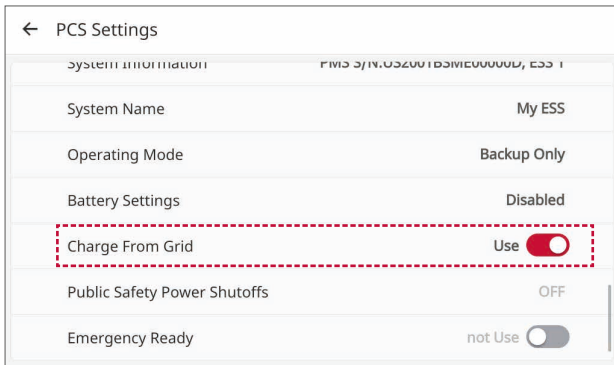

INFO

To use the [Emergency Ready] function, the system must be registered through the LG ThinQ® application.

Using LG ThinQ® Applications (For User)



INFO

To use the LG ThinQ® Application, the SE Box must be connected to the Internet.

Installing LG ThinQ®

Search for the LG ThinQ® application in the Google® Play Store or Apple® App Store® on a mobile phone.

Apple® and App Store® are registered trademarks of Apple, Inc.

Google® is a trademark of Google LLC.

Follow the instructions to download and install the application.



INFO

If you choose the simple login method to access the LG ThinQ® application, you must go through the system registration process each time you change your mobile phone or reinstall the application.

Registering the System

The SE Box should already be connected to a router or the Internet directly (For example, using an LTE modem)

1. Run the LG ThinQ® application on a mobile phone.
2. Create an account and sign in.
3. Select [Add a Device]-> [Select Device].
4. Select [ESS Home].

Using LG ThinQ®

On your SE Box

1. On your SE Box display, press  > [Settings] > [General Settings].
2. Set the [Soft AP] option to [Active] state.

On a Mobile Phone

1. Select the system in the application and connect it to a Wireless network.
2. Select the menu on the upper right side to access the settings and features.

Firmware Update

Keeps the system performance updated.

Settings

Allows you to set various options in the system and the application.



INFO

- If you change your wireless router, your Internet service provider, or your password after registering the appliance, please delete the network in LG ThinQ® Settings > Edit Product and register it again.
- The application is subject to change for appliance improvement purposes without notice.
- Functions may vary by model.



INFO

- To verify the Wi-Fi connection, check that the Wireless icon on the control panel is lit.
- The appliance supports 2.4GHz wireless networks only. To check your network frequency, contact your Internet service provider or refer to your wireless router manual.
- LG ThinQ® is not responsible for any network connection problems or any faults, malfunctions, or errors caused by network connection.
- If the system is having trouble connecting to the wireless network, it may be too far from the router.
- Purchase a wireless repeater (range extender) to improve the wireless signal strength.
- The wireless connection may not connect or may be interrupted due to the home network environment.
- The network connection may not work properly depending on the Internet service provider.
- The surrounding wireless environment can cause the wireless network service to run slowly.
- The appliance may not be able to be registered due to problems with the wireless signal transmission.
- Unplug the appliance and wait about a minute before trying again.
- If the firewall on your wireless router is enabled, disable the firewall or add an exception.
- The wireless network name (SSID) should be a combination of English letters and numbers. (Do not use special characters.)
- The smartphone user interface (UI) may vary depending on the mobile operating system (OS) and the manufacturer.
- If the security protocol of the router is set to WEP, you may fail to set up the network. Please change it to another security protocol (WPA2 is recommended) and register the product again.
- If the system is not available to connect to a wireless network, request an installer to connect the system through a wired connection and use the LG ThinQ® app with mobile data or cellular data.

Error Codes and Messages

PCS Error Codes

- Do not leave the ESS in a faulty state for a long time, as the remaining battery capacity may be decreased during that period.
- If the BMS generates fault information and disconnects the power after starting PCS, it means that the battery has a problem. Check the battery SoC, voltage, and fault information and turn off the power of the ESS until service is performed.
- If the battery SoC is low, the battery may be charged from the grid by using the self protection function (Emergency charging). This function is to prevent the shutdown of the ESS, battery deep discharge, and battery damage. Emergency charging is not an ESS fault, but a normal procedure.

Code	Description	Solution
P105	BAT 1 Disconnect	Contact service center
P110	BAT 1 MisWiring	Contact service center
P120	Grid MisWiring	Contact service center
P130	BAT Relay Error	Contact service center
P131	Grid Relay Error	Contact service center
P140	Slave MCU Comm.	Contact service center
P141	PMS Comm. Error	Contact service center
P142	BAT Comm. Error	Contact service center
P150	Backup SoftStart	Contact service center
P151	Backup Fail	Reboot the system
P152	Backup Low SOC	Automatically restart after releasing fault
P203	Grid OV	Automatically restart after grid voltage is normal
P213	Grid UV	Automatically restart after grid voltage is normal
P220	Grid OF	Automatically restart after grid frequency is normal
P221	Grid UF	Automatically restart after grid frequency is normal
P230	L1 DC OffsetCurr	Automatically restart after releasing fault
P240	Anti-Islanding	Automatically restart after releasing fault
P300	BAT 1 OV	Automatically restart after battery voltage is normal
P310	BAT 1 UV	Automatically restart after battery voltage is normal
P320	BAT 1 OC	Automatically restart after battery current is normal
P330	BAT 1 OC HW	Automatically restart after battery current is normal
P350	BAT 1 Low SOC	Automatically restart after battery SOC is normal
P351	BAT1 State Error	Automatically restart after battery state is normal

Code	Description	Solution
P353	BAT 1 Sleep	Automatically restart after battery black start operation is normal
P354	BAT 1 Power Down	Automatically restart after battery black start operation is normal
P370	DC Link OV	Automatically restart after DC-Link voltage is normal
P371	DC Link OV HW	Automatically restart after DC-Link voltage is normal
P372	DC Link UV	Automatically restart after DC-Link voltage is normal
P500	Grid L1 OC	Automatically restart after grid current is normal
P503	Grid N OC	Automatically restart after grid current is normal
P510	Grid L1 OC HW	Automatically restart after grid current is normal
P513	Grid N OC HW	Automatically restart after grid current is normal
P550	Backup L1 OV	Automatically restart after releasing fault
P551	Backup L2 OV	Automatically restart after releasing fault
P560	Backup Total OL	Automatically restart after releasing fault
P561	Backup L1 OL	Automatically restart after releasing fault
P562	Backup L2 OL	Automatically restart after releasing fault
P580	Backup Volt Fail	Automatically restart after releasing fault
P600	Grid Relay1	Automatically restart after releasing fault
P601	Grid Relay2	Automatically restart after releasing fault
P602	Grid Relay3	Automatically restart after releasing fault
P603	Grid Relay4	Automatically restart after releasing fault
P604	Grid Relay5	Automatically restart after releasing fault
P605	Grid Relay6	Automatically restart after releasing fault
P606	Grid Relay7	Automatically restart after releasing fault
P607	Grid Relay8	Automatically restart after releasing fault
P612	BAT Relay1	Automatically restart after releasing fault
P613	BAT Relay2	Automatically restart after releasing fault
P631	Inverter SW1 OT	Automatically restart after INV L1 top temp is normal
P632	Inverter SW2 OT	Automatically restart after INV L1 bottom temp is normal
P633	Inverter SW3 OT	Automatically restart after INV L2 top temp is normal
P634	Inverter SW4 OT	Automatically restart after INV L2 bottom temp is normal
P635	Inverter SW5 OT	Automatically restart after INV N top temp is normal
P636	Inverter SW6 OT	Automatically restart after INV N bottom temp is normal
P651	BAT Conv. SW1 OT	Automatically restart after Converter top temp is normal
P652	BAT Conv. SW2 OT	Automatically restart after Converter bottom temp is normal
P690	PCS Internal OT	Automatically restart after Inner temp is normal
P700	Slave MCU Comm.	Automatically restart after Communication is normal

Code	Description	Solution
P701	PMS Comm. Error	Automatically restart after Communication is normal
P702	BAT1 Comm. Error	Automatically restart after Communication is normal
P720	Slave MCU Error	Automatically restart after releasing fault
P721	MCU Power Fault	Automatically restart after MCU Control Power is normal
P722	GD Desat	Automatically restart after releasing fault
P723	GD Low Voltage	Automatically restart after releasing fault
P724	Temp. Sensor	Automatically restart after temp. sensor is normal
P740	ATS Error	Automatically restart after ATS is normal
P741	Initial Charge	Automatically restart after releasing fault
P750	Grid Volt Sensor	Automatically restart after grid voltage sensing is normal
P751	Grid Freq Sensor	Automatically restart after grid frequency sensing is normal
P752	Safety Function	Automatically restart after safety function operation is normal
P753	Micom State Fail	Automatically restart after MICOM state is normal
P760	SRD Para Fault	Automatically restart after releasing fault
P765	Relay Power Off	Automatically restart after relay is normal
P900	SRD Para Warning	Automatically restart after releasing fault
P910	Eeprom Warning	Automatically restart after releasing fault
P925	PMS E-Stop	Automatically restart after releasing stop

SE Box Error Code

Code	Description	Solution
S100	PCS version does not match	Contact service center
S101	BMS version does not match	Contact service center
S102	EEPROM device error	Contact service center
S200	Grid meter communication error	Contact service center
S201	Grid L1 is miswired	Contact service center
S202	Grid L2 is miswired	Contact service center
S203	PV meter communication error	Contact service center
S204	PV meter is miswired	Contact service center
S205	PV meter is miswired	Contact service center
S207	Load Relay Open	In backup operation, Load Relay can be opened. If this fault happens in the grid connected mode, please contact service center

Code	Description	Solution
S210	Grid L1 CT Open	Reboot the system in HMI menu. This fault still persist after the system reboot, please contact service center
S211	Grid L1 CT Short	Reboot the system in HMI menu. This fault still persist after the system reboot, please contact service center
S212	Grid L2 CT Open	Reboot the system in HMI menu. This fault still persist after the system reboot, please contact service center
S213	Grid L2 CT Short	Reboot the system in HMI menu. This fault still persist after the system reboot, please contact service center
S214	Grid L1 CT Fail	Reboot the system in HMI menu. This fault still persist after the system reboot, please contact service center
S215	Grid L2 CT Fail	Reboot the system in HMI menu. This fault still persist after the system reboot, please contact service center
S216	Volt Sensor Fail	Reboot the system in HMI menu. This fault still persist after the system reboot, please contact service center

Battery Error Code

Code	Description	Solution
B050	Discharge current level is higher than the limit	Automatically released after warning condition is cleared
B051	Charge current level is higher than the limit	Automatically released after warning condition is cleared
B053	Discharge Atmosphere temperature level is higher than the limit	Automatically released after warning condition is cleared
B054	Discharge Atmosphere temperature level is lower than the limit	Automatically released after warning condition is cleared
B055	Charge Atmosphere temperature level is higher than the limit	Automatically released after warning condition is cleared
B056	Charge Atmosphere temperature level is lower than the limit	Automatically released after warning condition is cleared
B100	Discharge temperature level is higher than the limit	Automatically released after warning condition is cleared
B101	Discharge temperature level is lower than the limit	Automatically released after warning condition is cleared
B102	Charge temperature level is higher than the limit	Automatically released after warning condition is cleared
B103	Charge temperature level is lower than the limit	Automatically released after warning condition is cleared

Code	Description	Solution
B104	Power Terminal temperature level is higher than the limit	Automatically released after warning condition is cleared
B150	Discharge Power level is higher than the limit	Automatically released after warning condition is cleared
B151	Charge Power level is higher than the limit	Automatically released after warning condition is cleared
B153	MCU AD interrupt operation warning	Automatically released after warning condition is cleared
B155	Fan is not working	Automatically released after ESS system restart
B157	CRC data safety memory range warning	Contact service center
B300	Cell Voltage level of battery cell is higher than the limit	Automatically restart after fault condition is cleared
B301	Cell Voltage level of battery cell is lower than the limit	Contact service center
B305	Unit voltage AD conversion multiplex fault	Automatically restart after fault condition is cleared
B350	Discharge current level is higher than the limit	Automatically restart after fault condition is cleared
B351	Charge current level is higher than the limit	Automatically restart after fault condition is cleared
B353	Discharge Atmosphere temperature level is higher than the limit	Automatically restart after fault condition is cleared
B354	Discharge Atmosphere temperature level is lower than the limit	Automatically restart after fault condition is cleared
B355	Charge Atmosphere temperature level is higher than the limit	Automatically restart after fault condition is cleared
B356	Charge Atmosphere temperature level is lower than the limit	Automatically restart after fault condition is cleared
B357	Current AD conversion multiplex fault	Automatically restart after fault condition is cleared
B400	Discharge temperature level is higher than the limit	Automatically restart after fault condition is cleared
B401	Discharge temperature level is lower than the limit	Automatically restart after fault condition is cleared
B402	Charge temperature level is higher than the limit	Automatically restart after fault condition is cleared
B403	Charge temperature level is lower than the limit	Automatically restart after fault condition is cleared

Code	Description	Solution
B404	Power Terminal temperature level is higher than the limit	Automatically restart after fault condition is cleared
B458	MCU OSC HR error	Automatically restart after releasing fault
B459	Internal Communication Error (BCU ↔ BIC)	Automatically restart after releasing fault
B460	External Communication Error (BCU ↔ PCS)	Automatically restart after releasing fault
B461	Watchdog counter error	Automatically restart after releasing fault
B463	MCU CORE register error	Automatically restart after releasing fault
B464	MCU FPU register error	Automatically restart after releasing fault
B465	MCU VCU register error	Automatically restart after releasing fault
B466	MCU PIE RAM error	Automatically restart after releasing fault
B467	MUC PIE handler error	Automatically restart after releasing fault
B468	MCU ROM ECC error	Automatically restart after releasing fault
B469	MCU RAM ECC error	Automatically restart after releasing fault
B470	MCU clock error	Automatically restart after releasing fault
B471	MCU RAM 1 error	Automatically restart after releasing fault
B472	MCU RAM 2 error	Automatically restart after releasing fault
B473	MCU oscillator source error	Automatically restart after releasing fault
B600	Cell Voltage level of battery cell is higher than the limit	Contact service center
B601	Cell Voltage level of battery cell is lower than the limit	Contact service center
B603	Unit Voltage level of battery cell is higher than the limit	Contact service center
B604	Unit Voltage level of battery cell is lower than the limit	Contact service center
B606	Cell voltage difference between battery cells is higher than the limit	Contact service center
B607	Pack voltage difference between battery packs is higher than the limit	Contact service center
B650	Discharge current level is higher than the limit	Contact service center
B651	Charge current level is higher than the limit	Contact service center
B653	Discharge Atmosphere temperature level is higher than the limit	Contact service center
B654	Discharge Atmosphere temperature level is lower than the limit	Contact service center
B655	Charge Atmosphere temperature level is higher than the limit	Contact service center

Code	Description	Solution
B656	Charge Atmosphere temperature level is lower than the limit	Contact service center
B700	Discharge temperature level is higher than the limit	Contact service center
B701	Discharge temperature level is lower than the limit	Contact service center
B702	Charge temperature level is higher than the limit	Contact service center
B703	Charge temperature level is lower than the limit	Contact service center
B704	Power Terminal temperature level is higher than the limit	Contact service center
B754	Battery power supply relay operation fault	Contact service center
B756	Reset count error	Contact service center
B758	BIC AD reference voltage error	Contact service center
B759	Cell sensor wire connection error	Contact service center
B760	Temperature sensor error	Contact service center
B761	Current sensor error	Contact service center
B764	Unit high voltage sensor error	Contact service center
B765	Circuit breaker switch is open	Contact service center
B766	Fault checking operation error	Contact service center
B767	Battery pack count error	Contact service center
B768	MCU AD conversion error	Contact service center
B769	Cell temperature AD conversion error	Contact service center
B770	Cell voltage AD conversion	Contact service center
B771	MCU AD reference voltage error	Contact service center

- Firmware version, Error codes, and Fault conditions can be accessed on the display. They can also be accessed from the server.

Contact

If you have any technical problems or questions, contact the installation company or LGEUS.

1. Installation Company Address :
2. LG Electronics ESS Tech Support
Tel.: (844) 926-6829
Or by email: lghome8support@lge.com

Black Start

Black Start is a wake-up function for when the Home 5/8 is in sleep mode.

The Home 5/8 will go into sleep mode to protect the battery from over-discharging when the SoC of the Home 5/8 has reached 0 %. (e.g. In case the surplus energy from the PV system is not enough to charge the battery during a power outage.)

The user or installer should press and hold the BLACK START (6s) button for more than 6 seconds when the battery can be recharged by the PV system or the utility grid. If 2 or more Home 5/8 units are installed, press the BLACK START (6s) button on each Home 5/8 unit.

This feature could be still used in a power outage. In general, during a power outage, the PV system will not operate if the Home 5/8 is in sleep mode due to reaching 0 % SoC with no backup power. In this case, however, the user or installer can wake up the Home 5/8 in the morning, and then the Home 5/8 will be charged from the PV system WITHOUT supplying the backup load. Once the SoC of the Home 5/8 has reached the specific SoC level and has met other conditions, the system will automatically supply the backup power to the backup load with the PV system.

The user or installer should wake up the Home 5/8 even though the utility grid has been recovered after the Home 5/8 is in sleep mode. In this case, the Home 5/8 will be charged from the utility grid up to the specific SoC level and the system will automatically operate following the pre-set operating mode.

INFO

- SoC 0% means the battery has run out of capacity. When the SoC reaches 0%, an alarm is sent through EnerVu and the LED Indications display 0%.
- When running the Black Start function, the battery will first start charging, and after a certain amount of charging, the system will operate normally using battery power.
- Before pressing the BLACK START (6s) button, make sure that the PV is operating normally.

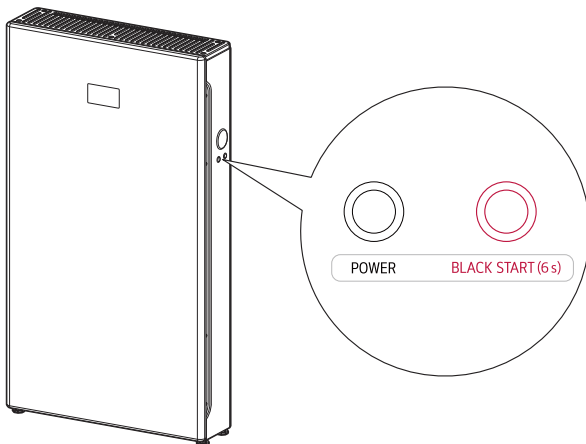

Maintenance



WARNING

Be sure to turn off the product and inspect it.

Cleaning the Product

Wipe off the outside of the product with a soft towel moistened with lukewarm water and a neutral detergent, then wipe it with a clean hand towel so that dirt will not be attracted to the product.

When cleaning the outside of the product, do not use a rough brush, toothpaste, or flammable materials. Do not use cleaning agents containing flammable substances.

- It may cause discoloration or damage the product.
- Flammable substances: Alcohol (Ethanol, Methanol, Isopropyl alcohol, Isobutyl alcohol, etc.), Thinners (Benzene, Flammable liquid, Abrasives, etc.)

Cleaning with strong pressure while cleaning may damage the surface. Do not leave rubber or plastic products in contact with the product for a long period of time.

Inspecting Regularly

It is recommended to check the operating status and connection status at least once a year. It should be done by a trained service provider. Contact an authorized dealer or the seller you purchased the system from.

- The capacity may decrease as the battery ages.
- The value for the battery cell only (depth of discharge 95%) capacity may be limited to protect the system.

Shutting Down the System

The ESS should be turned off when not in use for a long period of time or when maintenance is required.

1. Open the front cover of the SE Box. Set the  > [Settings] > [PCS Settings] > [Operation] option on the SE Box display to [Stop].

If the optional STOP SWITCH is connected to the SE Box, operate the STOP switch and check that the  > [Settings] > [PCS Settings] > [Operation] option on the SE Box display is set to [Stop].

2. Press the POWER button on the Home 5/8 and open the front door of the Home 5/8.
3. Switch the battery circuit breaker on the Home 5/8 to the OFF position and close the front case of the Home 5/8.
4. Switch every circuit breakers on the SE Box side to the OFF position and close the front case of the SE Box.

Compliance Information

[USA]

FCC Notice

The following notice covers the transmitter module contained in this product.

This equipment has been tested and found to comply with the limits for a Class B digital device, pursuant to Part 15 of the FCC Rules. These limits are designed to provide reasonable protection against harmful interference in a residential installation. This equipment generates, uses, and can radiate radio frequency energy and, if not installed and used in accordance with the instructions, may cause harmful interference to radio communications. However, there is no guarantee that interference will not occur in a particular installation. If this equipment does cause harmful interference to radio or television reception, which can be determined by turning the equipment off and on, the user is encouraged to try to correct the interference by one or more of the following measures:

- Reorient or relocate the receiving antenna.
- Increase the separation between the equipment and the receiver.
- Connect the equipment to an outlet on a circuit different from that to which the receiver is connected.
- Consult the dealer or an experienced radio/TV technician for help.

This device complies with Part 15 of the FCC Rules. Operation is subject to the following two conditions:

- 1) this device may not cause harmful interference; and
- 2) this device must accept any interference received, including interference that may cause undesired operation of the device.

Any changes or modifications in construction of this device which are not expressly approved by the party responsible for compliance could void the user's authority to operate the equipment.

FCC RF Radiation Exposure Statement

This equipment complies with FCC radiation exposure limits set forth for an uncontrolled environment. This equipment should be installed and operated with minimum distance 20 cm between the radiator and your body. End users must follow the specific operating instructions for satisfying RF exposure compliance. This transmitter must not be co-located or operating in conjunction with any other antenna or transmitter.

Supplier's Declaration of Conformity	
Trade Name	LG
Responsible Party	LG Electronics USA, Inc.
Address	111 Sylvan Avenue, North Building Englewood Cliffs, New Jersey 07632
E-mail	lg.environmental@lge.com

[CANADA]

Industry Canada Statement (For transmitter module contained in this product)

CAN ICES-3 (B)/NMB-3(B)

This device complies with Industry Canada's applicable licence-exempt RSSs. Operation is subject to the following two conditions:

- (1) This device may not cause interference; and
- (2) This device must accept any interference, including interference that may cause undesired operation of the device.

IC Radiation Exposure Statement

This equipment complies with IC radiation exposure limits set forth for an uncontrolled environment. This equipment should be installed and operated with a minimum distance of 20 cm (7.8 inches) between the antenna and your body.

NOTE: THE MANUFACTURER IS NOT RESPONSIBLE FOR ANY RADIO OR TV INTERFERENCE CAUSED BY UNAUTHORIZED MODIFICATIONS TO THIS EQUIPMENT. SUCH MODIFICATIONS COULD VOID THE USER'S AUTHORITY TO OPERATE THE EQUIPMENT.

Avis d'Industrie Canada [Pour la fonction sans fil (WLAN, Bluetooth, etc.)]

CAN ICES-003(B) / NMB-003(B)

L'émetteur/récepteur exempt de licence contenu dans le présent appareil est conforme aux CNR d'Innovation, Sciences et Développement économique Canada applicables aux appareils radio exempts de licence. L'exploitation est autorisée aux deux conditions suivantes :

- 1) L'appareil ne doit pas produire de brouillage;
- 2) L'appareil doit accepter tout brouillage radioélectrique subi, même si le brouillage est susceptible d'en compromettre le fonctionnement.

Avis d'Industrie Canada sur l'exposition aux rayonnements [Pour la fonction sans fil (WLAN, Bluetooth, etc.)]

Cet appareil est conforme aux limites d'exposition aux rayonnements d'Industrie Canada pour un environnement non contrôlé. Cet appareil doit être installé de façon à garder une distance minimale de 20 cm (7,8 po) entre la source de rayonnement et votre corps.

REMARQUE : LE FABRICANT N'EST PAS RESPONSABLE DES INTERFÉRENCES RADIOÉLECTRIQUES CAUSÉES PAR DES MODIFICATIONS NON AUTORISÉES APPORTÉES À CET APPAREIL. DE TELLES MODIFICATIONS POURRAIENT ANNULER L'AUTORISATION ACCORDÉE À L'UTILISATEUR DE FAIRE FONCTIONNER L'APPAREIL.

Specifications

Home 5/8 - General Specifications

Model	Home 5	Home 8
Nominal Voltage (L-N/L-L)	120/240V Split Phase	
Grid Frequency (Nominal)	60 Hz	
Rated AC Power (Discharging)	5.0 kVA ¹⁾	7.5 kVA ¹⁾
Rated AC Power (Charging)	5.0 kVA ¹⁾	5.4 kVA ¹⁾
Total Capacity	15.8 kWh	
Usable Capacity	14.4 kWh ²⁾	
Round Trip Efficiency	> 90 % ^{3) 4)}	
CEC Efficiency (PCS only)	98%	
Overvoltage Category	Category IV	
Interface	LED Display	

Home 5/8 - Grid connection mode

Model	Home 5	Home 8
Nominal Voltage (L-N/L-L)	120/240V Split Phase	
Grid Frequency (Nominal)	60 Hz	
Rated AC Power (Discharging)	5.0 kVA ¹⁾	7.5 kVA ¹⁾
Rated AC Power (Charging)	5.0 kVA ¹⁾	5.4 kVA ¹⁾
Rated AC Current (Discharging)	20.84 A	31.25 A
Rated AC Current (Charging)	20.84 A	22.5 A
Power Factor	- 0.8 — +0.8	

- 1) Adjustable, limited by the battery pack output capability such as charging/discharging power derating by the atmosphere temperature.
- 2) Usable energy may be limited for enhancing the battery lifespan and system stability. The capacity may decrease as the battery ages.
- 3) Verified according to LG Electronics conditions.
- 4) AC to battery to AC with 4.32 kW charging and 2.88kW discharging power at 25°C (77°F) at the beginning of life.

Home 5/8 - Backup mode

Model	Home 5	Home 8
Nominal AC Voltage	120/240V Split Phase	
Nominal AC Frequency	60 Hz	
Max AC Power (Discharging)	Total 9.0 kVA ¹⁾ 4.5 kVA @ 120 V (L1-N, L2-N)	
Rated AC Power (Discharging)	Total 5.0 kVA ¹⁾ 2.5 kVA @ 120 V (L1-N, L2-N)	Total 7.5 kVA ¹⁾ 3.75 kVA @ 120 V (L1-N, L2-N)
Rated AC Power (Charging)	Total 5.0 kVA ¹⁾ 2.5 kVA @ 120 V (L1-N, L2-N)	Total 5.4 kVA ¹⁾ 2.7 kVA @ 120 V (L1-N, L2-N)
Max AC Current (Discharging)	37.5 A (10s) ¹⁾ per line (L1,L2,N)	
Rated AC Current (Discharging)	20.84 A ¹⁾ per line (L1,L2,N)	31.25 A ¹⁾ per line (L1,L2,N)
Rated AC Current (Charging)	20.84 A ¹⁾ per line (L1,L2,N)	22.5 A ¹⁾ per line (L1,L2,N)

Home 5/8 - Battery

Battery Package Types	Cylindrical Li-ion
Total Capacity	15.8 kWh
Usable Capacity	14.4 kWh ²⁾
Nominal DC Voltage	406.56 V

Home 5/8 - Battery Module (Service Part)

Battery Package Types	Cylindrical Li-ion
Module Nominal DC Voltage	101.64 V
Module Capacity (min. / Nominal)	36.9 Ah / 38.9 Ah
Module Size [W*H*D]	600 x 212 X 190 [mm] (23.6 x 8.4 x 7.5 [in])
Module Weight (Max)	26 kg / 57 lb

- 1) Adjustable, limited by the battery pack output capability such as charging/discharging power derating by the atmosphere temperature.
- 2) Usable (typical) energy may be limited for enhancing the battery lifecycle and system stability. The capacity may decrease as the battery ages.

SE Box - General Specifications

Nominal Voltage (L-N/L-L)	120/240V Split Phase
Grid Frequency (Nominal)	60 Hz
Max AC Current Rating	200 A
Max Continuous AC Current Rating	160 A
Input Short Circuit Current Rating	10 kAIC ⁵⁾
Over Current Protection Device	100 ~ 200 A, Service Entrance Rated ^{5) 6)}
AC Meter Accuracy	+/- 2 %
Operating Mode	PV Self-Consumption, Time of Use (ToU), Backup Only
Backup Operation	Automatic Disconnect for Seamless Backup
Backup Transfer Time	< 100 ms
Modularity	Up to 4 Home 5/8 units
Overvoltage Category	Category IV

SE Box - Interfaces

User Interface	7-inch Touch LCD, LG ThinQ App (User), EnerVu Web (Installer)
Internet Connection	Ethernet 10/100, WLAN (802.11 b/g/n)
External Device	MODBUS

5) When protected by Class J fuses, LG SE Box is suitable for use in circuits capable of delivering no more than 22kA symmetrical amperes.

6) LG SE Box is not suitable for use as service equipment in Canada.

Environmental Specification

	Home 5/8	SE Box
Dimensions[W*H*D]	698 X 1260 X 205 [mm] (27.5 X 49.6 X 8.1 [in])	500 X 600 X 178 [mm] (19.7 X 23.6 X 7.0 [in])
Weight	163 kg / 359 lb	25 kg / 55 lb
Cooling	Fan (Forced Air Cooling)	Natural Convection
Operating Temperature	Discharging: -20 ~ 50 °C (-4 ~ 122 °F)	-20 ~ 50 °C (-4 ~ 122 °F)
	Charging: -10 ~ 45 °C (14 ~ 113 °F)	
Recommended Operating Temperature	Discharging: 0 ~ 35 °C (32 ~ 95 °F)	-20 ~ 50 °C (-4 ~ 122 °F)
	Charging: 0 ~ 33 °C (32 ~ 91.4 °F)	
Storage Temperature	-20 ~ 50 °C (-4 ~ 122 °F)	
Ambient Humidity (RH)	5 ~ 95 %	
Protection Rating	NEMA Type 3R ⁷⁾	
Altitude	< 3000 m (9843 ft)	
Seismic Category	IEEE 693	
Mounting Type	Floor Stand with Wall support	Wall Mount
Noise	< 47 dB	
Limited Warranty	See URL for full Limited Warranty ⁸⁾	

- Evaluation of surge : ± 4 kV(Power Line) / ± 2 kV(Communication port)

Compliance

	Home 5/8	SE Box
Grid Code	IEEE1547, IEEE1547.1, UL1741, CA Rule21	IEEE2030.5-2018 / Sunspec CSIP
Safety	UL1741, C22.2 No.107.1- 16,UL1642, UL1973, UL9540A	UL1741, C22.2 No.107.1-16, UL67 ⁹⁾ , UL869A ⁹⁾
Functional Safety	IEC60730-1 Annex H	-
System Safety	UL9540	
Enclosure	NEMA Type 3R ⁷⁾	
EMC	FCC Part15 Subpart B	
Seismic	IEEE 693	

7) Tested by IEC60068-2-52

8) Visit : <https://www.lg.com/us/ess/warranty>

9) Section from these standards were used during the safety evaluation and included in the UL1741 listing.

- Design and specifications are subject to change without notice.

Open Source Software Notice Information

To obtain the source code that is contained in this product, under GPL, LGPL, MPL, and other open source licenses that have the obligation to disclose source code, and to access all referred license terms, copyright notices and other relevant documents, please visit <https://opensource.lge.com>. LG Electronics will also provide open source code to you on CD-ROM for a charge covering the cost of performing such distribution (such as the cost of media, shipping, and handling) upon email request to opensource@lge.com. This offer is valid to anyone in receipt of this information for a period of three years after our last shipment of this product.

Arbitration

The laws of the State of New York govern this Limited Warranty and all of its terms and conditions, without giving effect to any conflicts of laws principles. All actions at law or in equity arising out of or relating to these terms and conditions shall be submitted to confidential arbitration in New York, New York. Arbitration under this Limited Warranty shall be conducted under the rules then prevailing of the American Arbitration Association. The arbitrator's award shall be binding and may be entered as a judgment in any court of competent jurisdiction. To the fullest extent permitted by applicable law, no arbitration under this Limited Warranty shall be joined to any legal proceeding or arbitration involving any other party, whether through class arbitration proceedings or otherwise.

Button cell or coin battery

⚠ WARNING	
<ul style="list-style-type: none"> • INGESTION HAZARD: This product contains a button cell or coin battery. • DEATH or serious injury can occur if ingested. • A swallowed button cell or coin battery can cause Internal Chemical Burns in as little as 2 hours. • KEEP new and used batteries OUT OF REACH of CHILDREN • Seek immediate medical attention if a battery is suspected to be swallowed or inserted inside any part of the body 	

The product contains non-replaceable batteries

- a) "Remove and immediately recycle or dispose of used batteries according to local Regulations and keep away from children. Do NOT dispose of batteries in household trash or Incinerate."
- b) "Even used batteries may cause severe injury or death."
- c) "Call a local poison control center for treatment information."
- d) Compatible battery type is ML2032 (e.g., LR44, CR2032).
- e) Nominal battery voltage 3.0V.
- f) "Non-rechargeable batteries are not to be recharged."
- g) "Do not force discharge, recharge, disassemble, heat above 140 °F or incinerate. Doing so may result in injury due to venting, leakage or explosion resulting in chemical burns."



LG Electronics ESS Tech Support

Tel.: (844) 926-6829

Or by email: lghome8support@lge.com

LG Electronics USA, Inc.

111 Sylvan Avenue North Building Englewood Cliffs,
NJ 07632 USA

LG Customer Information Center

1-888-865-3026

Register your product online!

<https://www.lg.com/us/ess>